

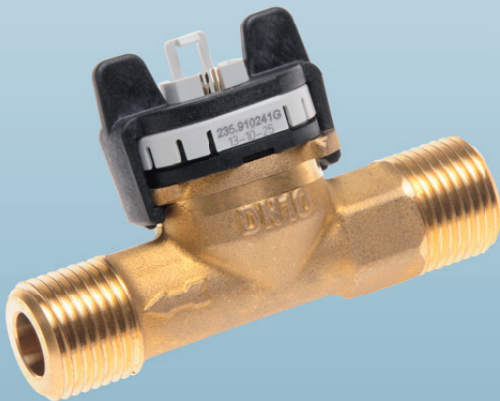

Vortex flow sensor

OEM Flow sensor for liquid media Type 235

The type 235 is based on the type 200 but incorporates a brass housing. The flow sensor type 235 is based on the Kármán vortex trail. You can choose between various versions as integrated temperature measurement. With no moving parts the flow sensor is not sensitive to debris, has marginal pressure loss and high accuracy.



Flow range

0.9 ... 240 l/min

Nominal diameters

DN 8 / 10 / 15 / 20 / 25 / 32

Temperature measurement

-40 ... +125 °C

- + Low cost product with high levels of accuracy
- + Temperature non-sensitive measuring principle
- + Excellent media resistance (measuring element not in contact with the media)
- + Wide application temperature range
- + Marginal loss of pressure
- + Measuring element not sensitive to debris
- + Direct temperature measurement in the medium with PT1000 or NTC
- + Drinking water approval ACS, WRAS

Technical Overview

Flow measurement

Measuring principle		Vortex	Piezoelectric sensor element
Measuring range			0.9 ... 240 l/min
Nominal diameters			DN 8 / 10 / 15 / 20 / 25 / 32
Accuracy at < 50% fs (water)			< 1% fs
Accuracy at > 50% fs (water)			< 2% measuring value
Response time	Immediately	Signal delay	< 100 ms
	Therefore suitable for spigot use.	Response time	< 5 ms

Temperature measurement

Measuring principle	Resistance		PT1000 NTC
PT1000	Measuring range		-40 ... +125 °C
	Accuracy	Class B DIN EN 60751	@ T = 0 °C ± 0.3 K @ T ≠ 0 °C ± 0.3 K ± 0.005 * ΔT
	Measuring range		-40 ... +125 °C
NTC	Accuracy	NTC 10 kOhm @ 25 °C β = 4050	@ T = +25 °C ± 0.7 K @ T < +25 °C ± 0.7 K ± 0.025 * ΔT @ T > +25 °C ± 0.7 K ± 0.050 * ΔT
Temperature influences		Self-heating at temperature sensor Conduction resistance to connector	1 K/mW 0.8 Ohm

Operating conditions

Medium	Suitable for heating circuit water with the usual additives Drinking water	Other medium on request
Temperature		Media < +125 °C Ambient -15 ... +85 °C Storage -30 ... +85 °C (for lifetime) 12 bar at +40 °C (for lifetime) 6 bar at +100 °C (for 600 hours) 4 bar at +125 °C (for 2 hours) 4 bar at +140 °C (max. test pressure) 18 bar at +40 °C
Max pressure and medium temperature		
Cavitation	The following equation is valid to prevent cavitation:	$P_{\text{abs. outlet}} / P_{\text{difference}} > 5.5$

Materials in contact with medium

Sensor paddle	ETFE
Case with damming body	Brass (CuZn40Pb2), PA6T/6I (40% GF)
Sealing material	EPDM (perox.) (for drinking water) FFM

Electrical overview

Power supply		U_{IN}	5 VDC ±5%
Output flow (Q)	Frequency Square pulse signal	$U_{OUT_Q_Frequency}$	< 0.1 ... > 4.75 V
Output temperature (T)	Resistant signal	R_{OUT_PT1000} R_{OUT_NTC}	PT1000 class B DIN EN 60751 NTC 10 kOhm @ 25 °C; β = 4050
Electrical connection and protection class		Connector RAST 2.5 / 2.54 Connector M12x1	IP 20 IP 65
Load against GND or IN			> 10 kOhm / < 10 nF
Current consumption I_{IN} load free		Version OEM Version standard	< 6 mA < 10 mA

Weight

	with thread K	with thread M	with thread G
DN 8 with condensation protection	~ 160 g	-	~ 206 g
DN 10 with condensation protection	~ 200 g	~ 241 g	~ 307 g
DN 15 with condensation protection	~ 222 g	-	~ 288 g
DN 20 with condensation protection	~ 356 g	-	~ 469 g
DN 25 with condensation protection	~ 576 g	-	~ 681 g
DN 32 with condensation protection	~ 691 g	-	-

Test / Admissions

Electromagnetic compatibility	acc. to EN 61326-2-3 (no protection at surge)
Drinking water approval	WRAS ACS Plastic parts with KTW and W270 approval

Packaging

Single packaging	
Multiple packaging	

Minimum life span on high flow rate and high temperature

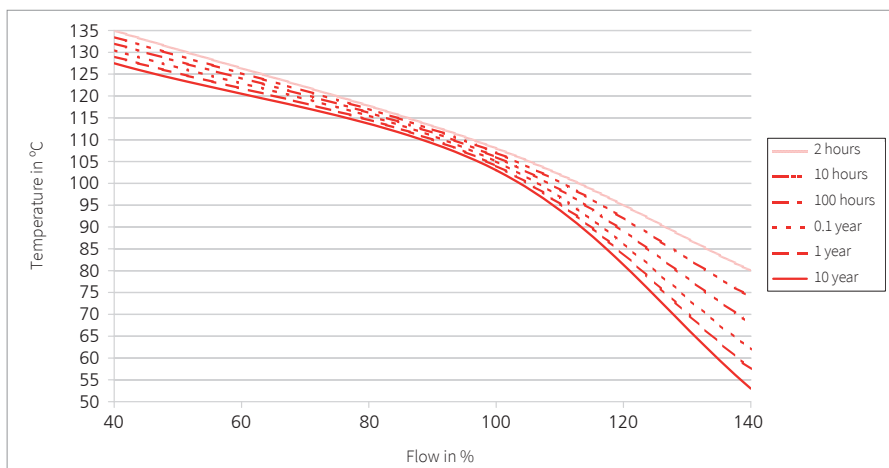

Nominal diameters dependent variables

Nominal diameters	Tube connection	Measuring range	Quantity per pulse @ 50% fs	Flow rate	Frequency range	Q ₀	K _f	Pressure drop ^{1),2)}
DN 8	K, G	0.9 ... 15 l/min.	0.578 ml	0.133 ... 2.210 m/s	31 ... 427 Hz	-0.2	0.0356	85.00 * Q ²
DN 10	K	1.8 ... 32 l/min	1.416 ml	0.265 ... 4.716 m/s	23 ... 374 Hz	-0.2	0.0860	22.50 * Q ²
	G, M		1.383 ml		24 ... 380 Hz		0.0840	
DN 10	K	2.0 ... 40 l/min	1.419 ml	0.295 ... 5.895 m/s	26 ... 467 Hz	-0.2	0.0860	22.50 * Q ²
	G, M		1.386 ml		26 ... 479 Hz		0.0840	
DN 15	K	3.5 ... 50 l/min	3.036 ml	0.290 ... 4.145 m/s	20 ... 273 Hz	-0.2	0.1836	6.70 * Q ²
	G		2.993 ml		20 ... 277 Hz		0.1810	
DN 20	K	5.0 ... 85 l/min	6.173 ml	0.265 ... 4.509 m/s	14 ... 229 Hz	-0.3	0.3730	2.50 * Q ²
	G		6.140 ml		14 ... 230 Hz		0.3710	
DN 25	K	9.0 ... 150 l/min	12.201 ml	0.283 ... 4.709 m/s	13 ... 205 Hz	-0.2	0.7340	0.92 * Q ²
	G		12.134 ml		13 ... 206 Hz		0.7300	
DN 32	K	14 ... 240 l/min	27.513 ml	0.290 ... 4.974 m/s	9 ... 145 Hz	-1.47	1.6710	0.25 * Q ²

Characteristic line formula frequency output

$$Q_v = K_f * f + Q_0$$

Formula quantity per pulse [litres/pulse]

$$\frac{\text{quantity}}{\text{pulse}} = \frac{Q_v * K_f}{60 * (Q_v - Q_0)}$$

Legend

Q _v	Volume flow rate	[l/min]
Q ₀	Axis intercept	[l/min]
K _f	Coefficient frequency output	[(l/min) / f]
f	Frequency	[Hz]
quantity / pulse	Quantity per pulse	litres / pulse

Order code selection table		1	2	3	4	5	6	7
		235. X X X X X X X						
Version	Flow	9						
	Flow and temperature (PT1000)	8			1			
Nominal diameters and flow range	Flow and temperature (NTC)	7			1			
	DN 8 0.9 ... 15 l/min.		0	8				K,G
	DN 10 1.8 ... 32 l/min.		1	0				
	DN 10 2.0 ... 40 l/min.		1	1				
	DN 15 3.5 ... 50 l/min.		1	5				K,G
	DN 20 5.0 ... 85 l/min.		2	0				K,G
	DN 25 9.0 ... 150 l/min.		2	5				K,G
Output / power supply	DN 32 14.0 ... 240 l/min.		3	2				K
	Frequency output, 0 ... 5 VDC (Square pulse signal)	5 VDC	OEM	9		0		
Electrical connection	Frequency output, 0 ... 5 VDC (Square pulse signal)	5 VDC	Standard			1		
	3-pole connector RAST 2.5			9			0	
	2x3-pole connector RAST 2.5			7,8		1	1	
	3-pole connector RAST 2.5	(condensation protection)		9			2	
	2x3-pole connector RAST 2.5	(condensation protection)		7,8		1	3	
	3-pole circular connector M12x1	(condensation protection)		9		1	4	
	5-pole circular connector M12x1	(condensation protection)		7,8		1	5	
Sealing material	EPDM Ethylene propylene rubber (peroxidically cross-linked)							1
	FPM ³⁾ Fluoro elastomer							2
Tube connection	Brass with outside thread	K (DN 8, 10 - G ½; DN 15 - G ¾; DN 20 - G 1; DN 25 - G 1 ¼; DN 32 - G 1 ½)						K
		M (DN 10 - G ¾)						M
		G (DN 8 - G ¾; DN 10 - G 1; DN 15 - G 1; DN 20 - G 1 ¼; DN 25 - G 1 ½)						G

Accessories (supplied loose)

Order number

Connector RAST 2.5 with cable	3-pole	30 cm		111668
Connector RAST 2.5 with cable	3-pole	110 cm		101817
Straight-wire box for connector M12x1 with cable	3-pole	200 cm		114605
Corner-wire box for connector M12x1 with cable	3-pole	200 cm		114604
Connector RAST 2.5 with cable	2x3 pole	110 cm	(with temperature)	114629
Straight-wire box for connector M12x1 with cable	5-pole	200 cm	(with temperature)	114564
Corner-wire box for connector M12x1 with cable	5-pole	200 cm	(with temperature)	114563
Straight-wire box for connector M12x1 screwing terminal	5-pole			115024

¹⁾ incl. 3xDI inlet and outlet side

²⁾ Pv in Pa; Q in l/min

³⁾ No drinking water approval

Dimension diagram

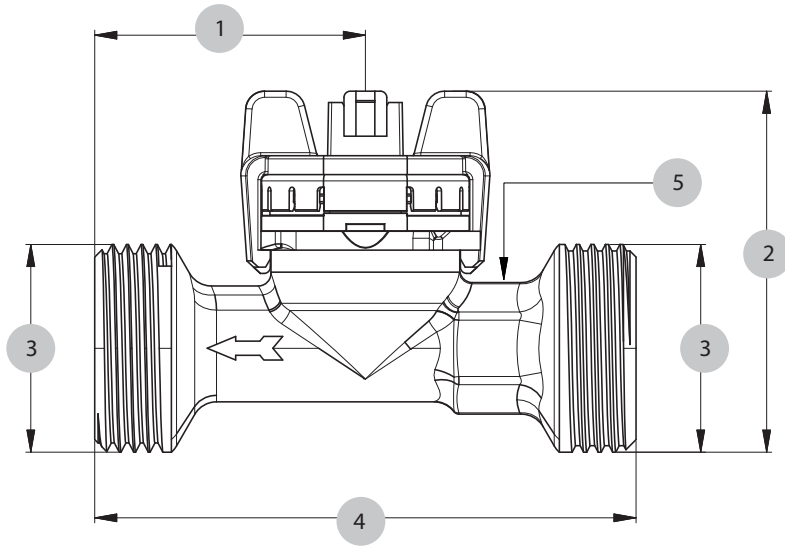

	1	2	3	4	5
DN8 K	33.3	52.9	G ½	77	↻ 15
DN8 G	33.3	55.7	G ¾	77	↻ 15
DN10 K	43	51.1	G ½	86	↻ 19
DN10 M	43	54.1	G ¾	86	↻ 19
DN10 G	43	57.3	G 1	86	↻ 19
DN15 K	41	55.9	G ¾	87	↻ 22
DN15 G	41	59.3	G 1	87	↻ 22
DN20 K	40.6	61.3	G 1	105	↻ 27
DN20 G	40.6	65.6	G 1 ¼	105	↻ 27
DN25 K	50	68.1	G 1 ¼	120	↻ 34
DN25 G	50	71.1	G 1 ½	120	↻ 34
DN32 K	50	74.9	G 1 ½	134	↻ 41

Tube mounting instructions

Consider the following to ensure the correct function of the sensor.

- Only diameter changes from large to small are allowed.
- Avoid repeated elbows in the same level at entryside

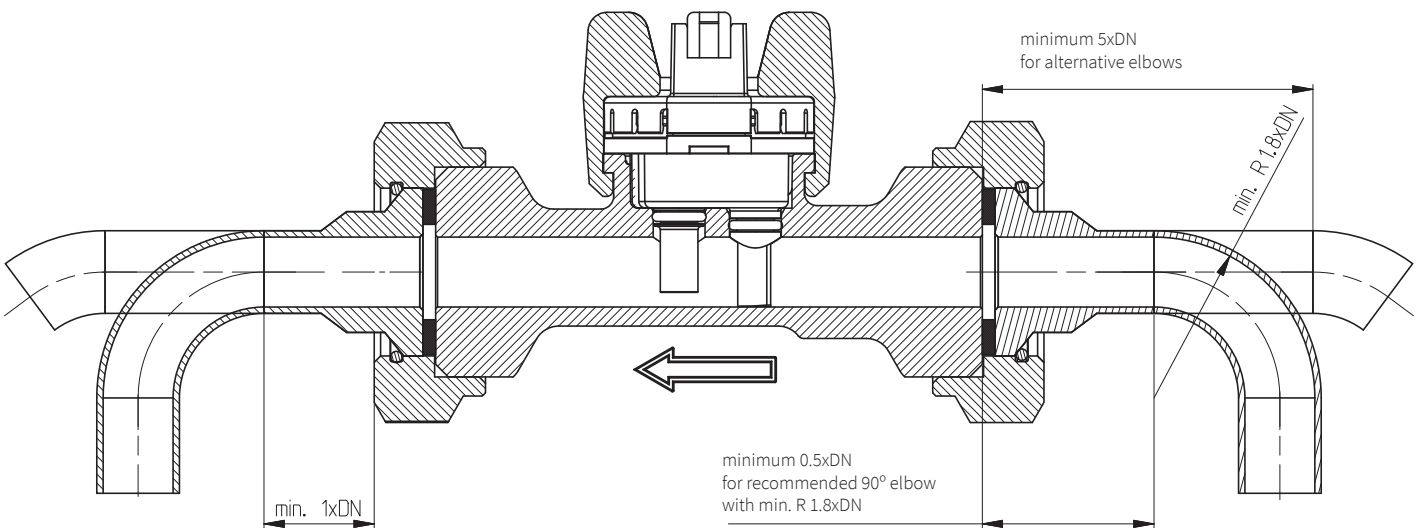

Electrical connections

RAST 2.5 without temperature output

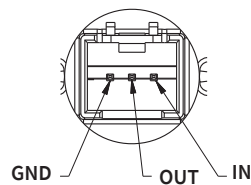
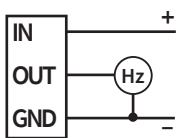

Connector M12x1 without temperature output

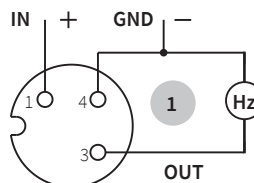

Pin	Colour
1	brown
3	blue
4	black
1	brown
2	white
3	blue
4	black
5	gray

Connector 2x3-poles with temperature output

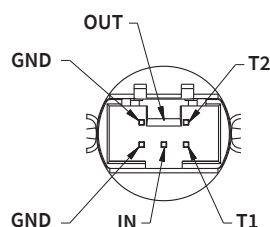
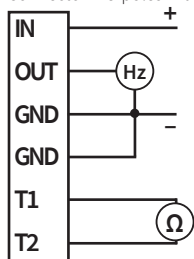

Connector M12x1 with temperature output

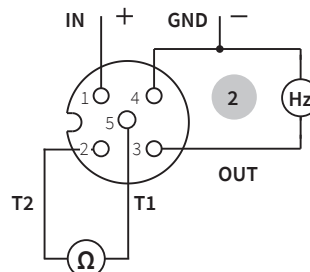

Influence of glycol

With the following definitions we are able to correct the influence of media with higher viscosity than water (= media viscosity > 1.8 cSt) in order to reach a measuring accuracy of 3% fs in the range of 1.8 - 4 cSt and of 4% in the range of 4 - 14 cSt (ν = viscosity in cSt).

Definition of viscosity of glycol-water-compound

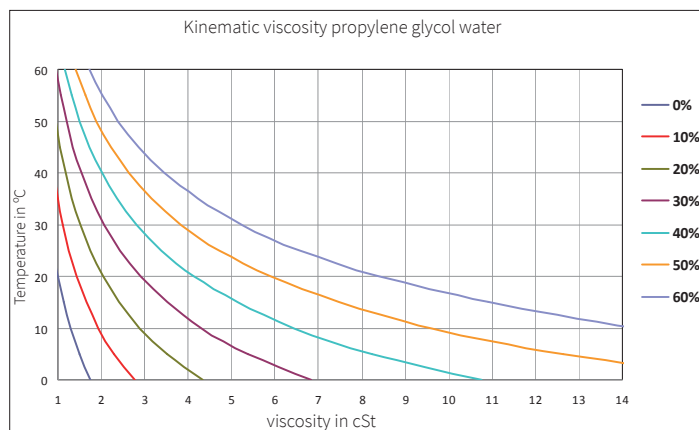
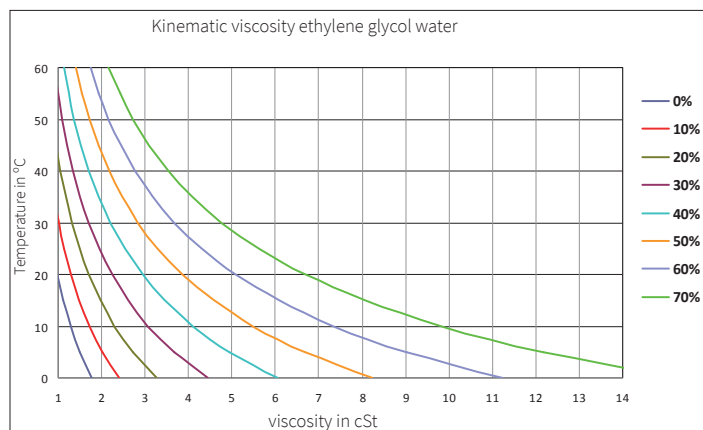

Definition of respond threshold Q_{min}

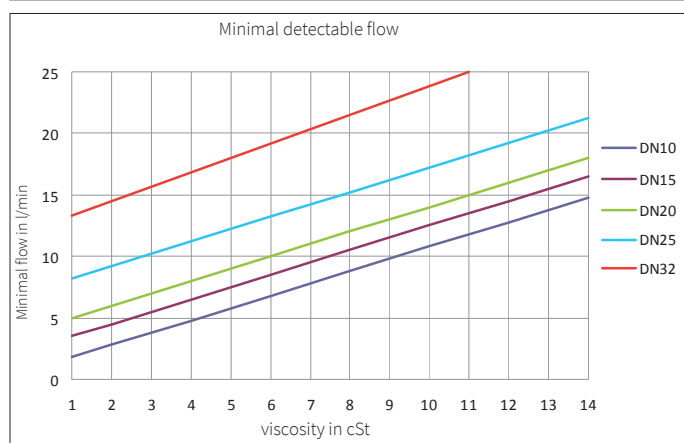

Definition of characteristic line formula $Q_v = k_f * f + Q_0$

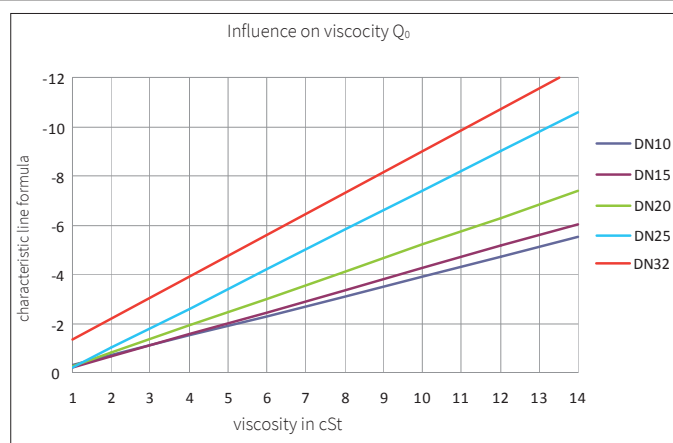

Formula respond threshold Q_{min} in l/min

< DN10 not possible

DN10: $Q_{min} = \nu + 0.8$

DN15: $Q_{min} = \nu + 2.5$

DN20: $Q_{min} = \nu + 4.0$

DN25: $Q_{min} = \nu + 8.0$

DN32: $Q_{min} = \nu + 13.0$

Formula characteristic line for $Q \geq Q_{min}$ in l/min

< DN10 not possible

Frequency output:

DN10: $Q = K_f * f - 0.40\nu + 0.20$

DN15: $Q = K_f * f - 0.45\nu + 0.25$

DN20: $Q = K_f * f - 0.55\nu + 0.25$

DN25: $Q = K_f * f - 0.80\nu + 0.60$

DN32: $Q = K_f * f - 0.85\nu - 0.55$

Huba Control AG

Headquarters Schweiz
Industriestrasse 17
CH-5436 Würenlos
Telefon +41 56 436 82 00
Fax +41 56 436 82 82
info.ch@hubacontrol.com

Huba Control AG

Niederlassung Deutschland
Schlattgrabenstrasse 24
D-72141 Walddorfhäslach
Telefon +49 7127 2393 00
Fax +49 7127 2393 20
info.de@hubacontrol.com

Huba Control AG

Vestiging Nederland
Hamseweg 20A
NL-3828 AD-Hoogland
Telefoon +31 33 433 03 66
Telefax +31 33 433 03 77
info.nl@hubacontrol.com

Huba Control SA

Succursale France
Rue Lavoisier
Technopôle Forbach-Sud
F-57602 Forbach Cedex
Téléphone +33 3 87 84 73 00
Télécopieur +33 3 87 84 73 01
info.fr@hubacontrol.com

Huba Control AG

Branch Office United Kingdom
Unit 13 Berkshire House, County Park
Business Centre, Shivenham Road
Swindon - Wiltshire SN1 2NR
Phone +44 1993 77 66 67
Fax +44 1993 77 66 71
info.uk@hubacontrol.com

www.hubacontrol.com

